

Lecture 11. Single-photon states and single-photon sources.

A need for single photons. Recognizing and characterizing them. Various sources of single photons: atoms, quantum dots, molecules, NV-centers in diamond, heralded preparation using PDC or FWM.

1. A need for single photons

Here we finally get to the question: why does one need nonclassical light? Besides the answer that ‘it is interesting’, nonclassical light has important practical applications.

Quantum key distribution. The simplest Fock state, the single-photon one, $|\Psi\rangle = |1\rangle$, is required for quantum key distribution (QKD). QKD is based on the fact that it is impossible to measure the state of a single photon without destroying it. This provides the absolute security of information.

An example is the polarization state (a qubit):

$$|\Psi\rangle = \alpha|H\rangle + \beta|V\rangle, \quad |\alpha|^2 + |\beta|^2 = 1.$$

This state can be equivalently written as some arbitrarily polarized state, $|\Psi\rangle = |P\rangle$, which can be unambiguously distinguished from the orthogonal state $|P_\perp\rangle$ only with the corresponding Stokes measurement setup (Fig.1). If one does not know the state, he/she can only guess it and then destroy the photon without learning the information. An attempt of an eavesdropper to get the information secretly cannot be successful: he/she has to send exactly the same polarization state as received, and this is impossible (no-cloning theorem).

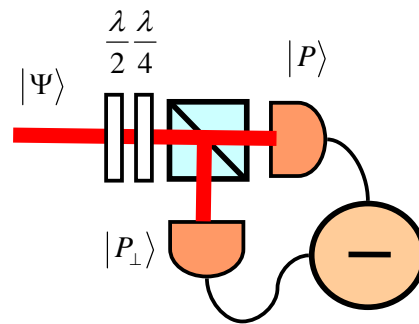

Fig.1

So ideally, in QKD the sender should send single-photon pulses. But (as we will learn soon) it is very difficult to prepare them. In most QKD setups, coherent state is used instead of the single-photon state, because at small amplitude it is approximately a single-photon state in combination with the vacuum:

$$|\alpha\rangle \approx |0\rangle + \alpha|1\rangle + \dots, \quad |\alpha| \ll 1. \quad (1)$$

But then, first, there is this vacuum term in the superposition. This means that if attenuated coherent pulses are sent to the receiver, most of these pulses contain no photons and the receiver waits in vain. Moreover, superposition (1) contains two-photon and higher-order states. Then, there is nonzero probability that an eavesdropper intercepts one photon of this state, measures its polarization and remains unnoticed.

Photons ‘on demand’ and probabilistically. For these reasons, the goal is to produce single-photon state ‘on demand’, that is, the state $|1\rangle$ without the vacuum term or higher-order terms. However, in many experiments one produces only $\alpha|0\rangle + \beta|1\rangle$ (probabilistic single photons) or $|1\rangle + \varepsilon|2\rangle$, $|\varepsilon| \ll 1$ (single photons in superposition with higher-order Fock states).

Quantum computation. If the state $|1\rangle$ can be produced (on demand, by pressing a button), then any higher-order Fock state $|N\rangle$, in principle, can be produced. And this can be used for quantum computation.

2. Recognizing and characterizing single photons

Anti-bunching is the distinguishing feature of a single-photon state. By sending the state into a Hanbury Brown and Twiss (HBT) interferometer one can measure its $g^{(2)}$ (Fig.2). Anti-bunching, $g^{(2)} < 1$, tells us that two-photon and higher-order components are absent. However, the HBT measurement is not sensitive to the vacuum in the superposition: for $|\Psi\rangle = |0\rangle + c|1\rangle$, $\langle (a^\dagger)^2 a^2 \rangle = 0$, hence $g^{(2)} = 0$. This will be also true for a mixture,

$$\rho = p_0|0\rangle\langle 0| + p_1|1\rangle\langle 1|.$$

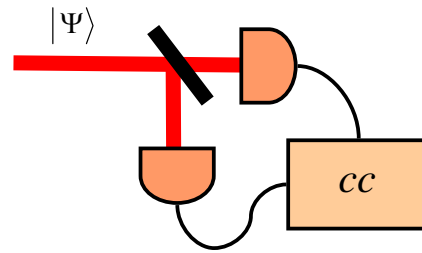

Fig.2

How can one understand that there is no vacuum component? Only by measuring the rate of single-photon registration. For instance, in the pulsed regime every pulse should result in a click in one of the detectors in fig.2 (at the same time they should not click simultaneously). This is only possible if the detectors have unity quantum efficiency. In other words, this is nearly impossible.

Hong-Ou-Mandel (HOM) effect. A very powerful tool for characterizing single-photon states is the HOM effect (discussed in Lecture 9). It is used whenever one wants to check whether photons $|\Psi_1\rangle$ and $|\Psi_2\rangle$ emitted by two different sources are similar (indistinguishable) or not. (One may ask how it is possible that $|1\rangle$ is different from $|1\rangle$. But remember that these states can be in different modes, $|1\rangle_a$ and $|1\rangle_b$, and also, in the general case, a single photon is 'spread' over a set of modes, forming a single-photon wavepacket $|\Psi\rangle = \int d\vec{k} f(\vec{k}) a^\dagger(\vec{k}) |0\rangle$. The amplitudes $f(\vec{k})$ can be different.)

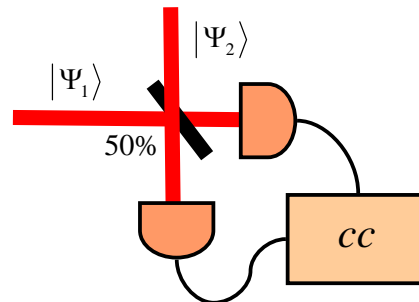

Fig.3

If the single-photon states at the inputs of the beamsplitter in Fig.3 are similar, there will be no coincidences registered. This was explained in detail in Lecture 7, but here is a simplified derivation. The 50% beamsplitter will transform the input operators as

$$\begin{pmatrix} a \\ b \end{pmatrix} \rightarrow \begin{pmatrix} a' \\ b' \end{pmatrix} = \frac{1}{\sqrt{2}} \begin{pmatrix} 1 & 1 \\ -1 & 1 \end{pmatrix} \begin{pmatrix} a \\ b \end{pmatrix};$$

$$a' = \frac{1}{\sqrt{2}}(a + b), \quad b' = \frac{1}{\sqrt{2}}(a - b).$$

This transformation can be inverted to get

$$a = \frac{1}{\sqrt{2}}(a' + b'), \quad b = \frac{1}{\sqrt{2}}(a' - b').$$

Then, the input state with one photon in each mode is

$$a^\dagger b^\dagger |0\rangle = \frac{1}{2} [(a'^\dagger)^2 - (b'^\dagger)^2] |0\rangle.$$

It becomes at the output a superposition of two-photon states in modes a' and b' ; however, there no photon pair $a'^+ b'^+ |0\rangle$. Hence, no coincidences will be observed.

3. Atoms: pioneering experiments and the current state of the art

It was understood in the 1970-s that a single atom with no two-photon transition allowed cannot emit two photons simultaneously: after the emission of a photon, it needs time to get to the excited level. The first experiment on the observation of anti-bunching was published by Kimble, Dagenais, and Mandel: PRL 39, 691-695 (1977) (Fig.4). They used a beam of Na atoms, excited them by laser radiation, collected the emitted light by a lens and sent it to a HBT interferometer. The resulting $g^{(2)}$ was about 0.4 at zero time delays. This was the first observation of anti-bunching.

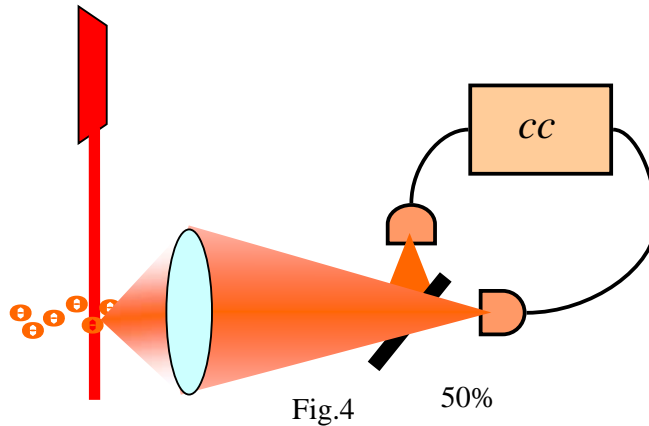

Nowadays, ions are used in most experiments instead of atoms. An ion can be easily trapped in an ion trap; moreover, there is no chance to have more than one ion in a trap as ions repulse. This provides the emission of single photons. (In the case of atoms, an atomic beam has to be rarified.)

The disadvantages of this technique are, first, the large size of the setups (they include cryogenic and vacuum equipment) and, second, the difficulty of collecting all the radiation emitted by an atom/ion. Basically it emits into 4π radians, and no lens can collect all this radiation. This is equivalent to losses and creates the state $\rho = p_0|0\rangle\langle 0| + p_1|1\rangle\langle 1|$ out of the single-photon state, even if the ion emits 'on demand'. For this reason, the 4PI-PAC group in MPL is placing a single ion into the focus of a deep parabolic mirror.

4. Solid-state emitters: quantum dots, molecules, NV centers in diamond,...

Much more convenient is to use solid-state single emitters. They can be excited efficiently by mounting them into a waveguide or antenna. The same way, their radiation can be efficiently collected. Historically, the first solid-state quantum emitters to be used were quantum dots.

A *quantum dot* is a small region of a semiconductor inside of another semiconductor. The region is so small (nanometer size) that it contains very few electron-hole pairs (excitons); basically, only one that can recombine and emit a photon. In this sense, a quantum dot is similar to an atom. Such quantum dots are obtained by epitaxial growth (self-assembled quantum dots).

The excitation/emission of a quantum dot (as well as other solid-state emitters) occurs according to the three-level scheme shown in Fig.5. The excitation (blue line) brings the dot to the state c from where it goes down (non-radiatively)

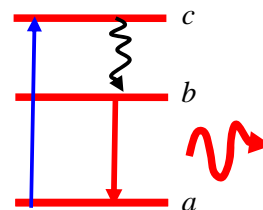

Fig.5

to state b. Then, it emits a photon and goes down to state a. The emission, therefore, can be easily separated from the excitation radiation.

The first work on obtaining single photons from quantum dots was P. Michler, A. Kiraz, C. Becher, W.V. Schoenfeld, P.M. Petroff, L.D. Zhang, E. Hu, and A. Imamoglu, *Science* **290**, 2282 (2000). They used InAs dots within GaAs; in the experiment it was necessary to work at helium temperatures to prevent thermal emission. The excitation was performed by a TiSa laser, and the measured correlation function (not normalized) was represented by a series of peaks (Fig.6B), the central one being absent. This demonstrated anti-bunching. For comparison, panel A shows the correlation function measured for the laser radiation.

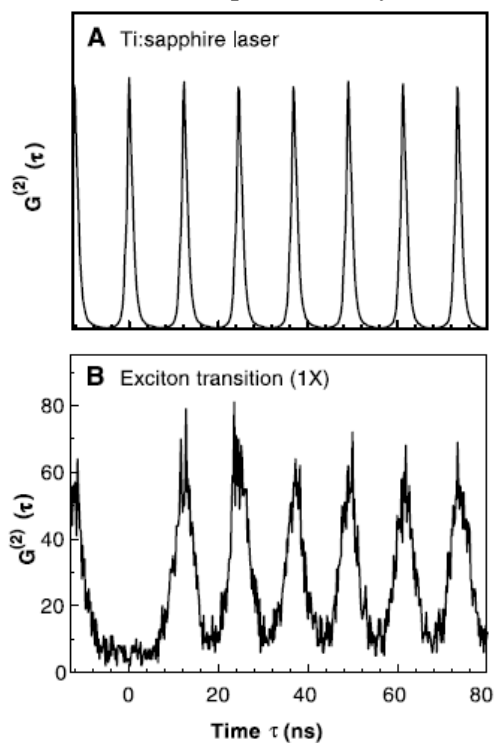

Fig.6

Colloidal quantum dots. Later, other types of quantum dots were synthesized, which are isolated from any other material and are obtained from solution and then coated on a substrate. For instance, CdSe spherical particles surrounded by a rod-like CdS shell. Such ‘dots in rods’ are currently studied in our lab. A disadvantage of these emitters is bleaching: under continuous illumination, such a dot gradually loses the ability to emit. Under pulsed illumination, however, it will emit for several days. Their advantages are: room-temperature operation and the convenience of coating on any surface. One of the early works on colloidal quantum dots: X. Brokmann, G. Messin, P. Desbieres, E. Giacobino, M. Dahan, and J.P. Hermier, *NJP* **6** 99 (2004).

For such a ‘dot-in-rod’, the emission has the same spatial distribution as that of a dipole, which makes it easy to collect.

Single molecules can also be used at room temperature. As single emitters, one can use organic molecules incorporated into a solid matrix. For instance, in one of the first papers on this, B. Lounis and W.E.Moerner, *Nature* **407** 491 (2000), molecules of terrylene in the matrix of p-terphenyl monocrystals were used. The experiment is shown in Fig.7. Left panel: the scheme of levels, the same principle as shown in Fig.5. Right panel: the experimental setup.

As in the cases of other solid-state single-photon emitters, usually the excitation beam is focused on the sample by the same objective lens (with high numerical aperture) as the one used for collecting the emitted radiation. The emitted radiation is then sent to a HBT interferometer. The central part of the figure shows the molecules

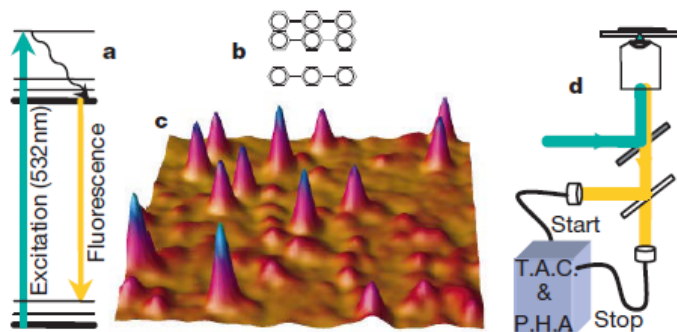

Fig.7

observed as the sample is scanned and the emission of the molecules is registered. Organic molecules suffer a lot from bleaching, much more than the colloidal dots.

Color centers in diamond are another type of solid-state single-photon emitters. Among them, most popular are centers formed by a vacancy (of a carbon atom) and a nitrogen atom, so-called NV-centers. They emit radiation at 637 nm; as a result, the diamond microcrystal with NV centers looks pink. They do not bleach, and also work at room temperatures. They have very high efficiency of emission (almost 100%). The only problem, as always, is to collect this radiation.

Methods of collection. Several methods have been proposed for making collection more efficient.

1. A micro lens is manufactured right above the emitter. This solves the problem of total internal reflection of the radiation emitted.
2. The directivity of radiation is formed by placing the emitter near a nanowire or on an antenna (based on the Purcell effect: spontaneous emission can only occur in the directions allowed by the environment. In a cavity, the rate of spontaneous emission depends on the Q factor and the mode volume of the cavity).
3. In connection with this, it is worth mentioning that an emitter placed on a dielectric substrate will emit much more in the direction of the substrate (due to the interference with its image in the dielectric). This enables almost a twofold increase in the collection efficiency.
4. Using external devices, such as a parabolic mirror.

5. *Heralded preparation of single photons using PDC or FWM.*

A completely different way of preparing single-photon states is based on spontaneous parametric down-conversion (SPDC) and spontaneous four-wave mixing (SFWM). As a result of both these processes, provided that the interaction is weak, the following state is generated:

$$|\Psi\rangle = |0,0\rangle + c|1,1\rangle + \dots$$

The term ‘...’ actually has the form $|\Psi\rangle = \frac{c^2}{\sqrt{2}}|2,2\rangle$ plus higher-order terms. However, it is small, since $|c| \ll 1$.

The method of single-photon preparation, realized first by C. K. Hong and L. Mandel, Phys. Rev. Lett. 56, 58 (1986), uses the scheme shown in Fig.8. PDC should be nondegenerate, i.e., signal and idler photons should be emitted in two different modes (in

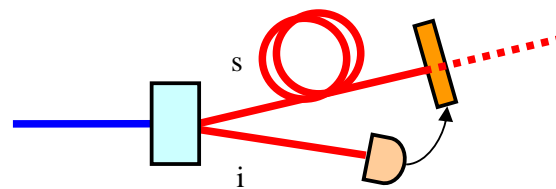

Fig.8

the figure, noncollinear). The idler photon is detected by a ‘click’ detector and after this, a ‘gate’ is opened for the signal detector. Of course, the signal photon must be delayed – for instance, by a fibre, - because the gate requires a finite time, on the order of 50-100 ns.

This procedure creates a state

$$|\Psi\rangle_s = |1\rangle_s + c|2\rangle_s + \dots$$

in the signal channel corresponding to each idler detector's 'click'. The higher-order components cannot be eliminated (but they are very small if c is small). Still, this state is an interesting nonclassical state of light and, for instance, its Wigner function is negative and it shows anti-bunching. This method of generating single-photon states is called 'heralded preparation'.

An important advantage of heralded single photons is their directivity: as SPDC or SFWM emit radiation that is rather narrowband in the angle, it is not difficult to collect such photons. Some QKD schemes use heralded single-photon states, which provides their higher security.