

Lecture 8.

Polarization in quantum optics: Stokes operators, uncertainty relations, single-photon state, Poincare sphere.

1. Why polarization?

Polarization plays a special role in quantum optics. The reason is that, because light waves are usually transverse (unless tight focusing is considered), polarization can be described in terms of dichotomic (binary) variables. This immediately gives an analogy with other quantum-mechanical ‘dichotomic’ systems: a two-level atom and a spin $\frac{1}{2}$ particle. The latter can be studied in a rather difficult Stern-Gerlach experiment (Fig.1, top): in a magnetic field, a spin $\frac{1}{2}$ particle is deflected up or down depending on the spin direction: $|\uparrow\rangle$ or $|\downarrow\rangle$. In general,

the state is a superposition of these two states:

$$|\Psi\rangle = \alpha|\uparrow\rangle + \beta|\downarrow\rangle, |\alpha|^2 + |\beta|^2 = 1.$$

But in an optics lab, the same experiment can be easily performed using a polarization prism (a Glan prism, for instance) and a single-photon state at the input (Fig.1, bottom). The prism transmits horizontally polarized light and reflects vertically polarized light and therefore allows one to distinguish between these two states. If the single-photon state is a superposition of a horizontally polarized and vertically polarized states, it is similar to the spin $\frac{1}{2}$ particle: $|\Psi\rangle = \alpha|H\rangle + \beta|V\rangle$. Such a state is

called in quantum information a qubit, a quantum bit of information: neither 1 nor 0 but a superposition, $|\Psi\rangle = \alpha|0\rangle + \beta|1\rangle$.

This polarization-based quantum encoding can be extended to be ternary and quaternary but it is the binary encoding that plays the most important role. It is with the help of polarized photons that the main fundamental result of quantum optics has been achieved (Bell’s inequality violation) and the most ‘practically important’ one as well (quantum key distribution).

2. Polarization in classical optics.

Polarization is always associated with the direction of the electric field. The simplest way to introduce it is to imagine that we can take a snapshot of the electric field vector. Or, that we can see the electric vector trajectory by eye. Then, there are various pictures (Fig.2), corresponding to linear, circular, and elliptic polarization. And a mixed state (unpolarized light) can be viewed as these three randomly mixed.

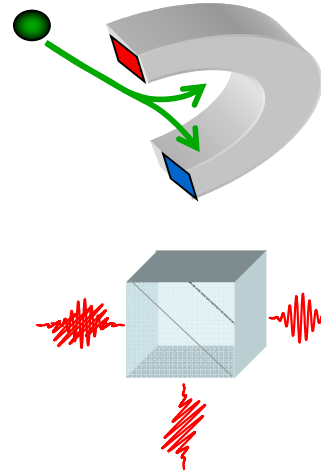

Fig.1

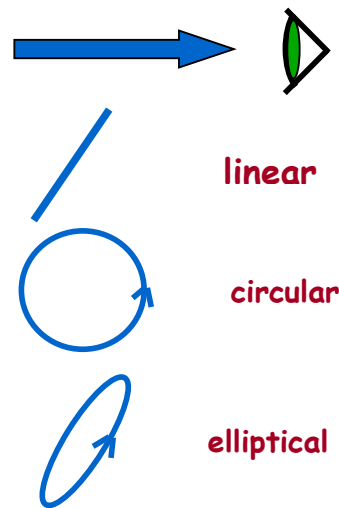

Fig.2

Quantitatively, polarization of light is described by the normalized complex Jones vector \vec{e} ,

$$\vec{e} \equiv \frac{1}{\sqrt{|E_H|^2 + |E_V|^2}} \{E_H; E_V\},$$

where E_H, E_V are the horizontally and vertically polarized parts of the analytic signal amplitude E_0 ($\vec{E}^{(+)} = \vec{E}_0 \exp\{i\omega t - i\vec{k}\vec{r}\}$). The Jones vector can be written as a pair of complex numbers,

$$\vec{e} = \{\alpha; \beta\}, \quad |\alpha|^2 + |\beta|^2 = 1, \text{ but the common phase is}$$

usually ignored, hence only the relative phase between the two components remains, and the Jones vector can be written in terms of two angles in the spherical system:

$$\vec{e} = \left\{ \cos \frac{\vartheta}{2}; e^{i\varphi} \sin \frac{\vartheta}{2} \right\}.$$

It is more convenient, instead of the complex-valued Jones vector, to use the real-valued Stokes vector, defined in terms of the following Stokes parameters:

$$S_0 \equiv |E_H|^2 + |E_V|^2, \quad S_1 \equiv |E_H|^2 - |E_V|^2, \\ S_2 \equiv 2 \operatorname{Re}\{E_H^* E_V\}, \quad S_3 \equiv 2 \operatorname{Im}\{E_H^* E_V\}.$$

They can be alternatively written in terms of intensities:

$$S_0 \equiv I_H + I_V, \quad S_1 \equiv I_H - I_V, \\ S_2 \equiv I_D - I_A, \quad S_3 \equiv I_L - I_R,$$

where I_H, I_V, I_D, I_A are intensities in the horizontal, vertical, diagonal (45 degrees linear), anti-diagonal (-45 degrees), left and right polarization modes. (One can check that, for instance, $2 \operatorname{Re}\{E_H^* E_V\} = I_D - I_A$, etc.) The Stokes vector can be defined as

$$\vec{S} \equiv \{S_1; S_2; S_3\},$$

and because $S_1^2 + S_2^2 + S_3^2 = S_0^2$ (check!), one can introduce the normalized Stokes vector

$$\vec{\sigma} \equiv \frac{1}{S_0} \{S_1; S_2; S_3\}.$$

By writing $\vec{\sigma}$ components in terms of \vec{e} components, one can find that $\vec{\sigma} = \{\cos \vartheta; \sin \vartheta \cos \varphi; \sin \vartheta \sin \varphi\}$.

The Stokes parameters can be measured in a simple experimental setup (Fig.4) with two detectors placed after a polarization prism. The S_0 parameter is measured as the sum of the detectors' photocurrents (total intensity). Then, S_1 is given by the difference of the photocurrents with no elements placed in front of the prism. If the prism is 45 degrees rotated, the same combination of photocurrents yields the S_2 parameter. For obtaining S_3 , one should transform left-circular polarization into vertical polarization and right-circular into horizontal.

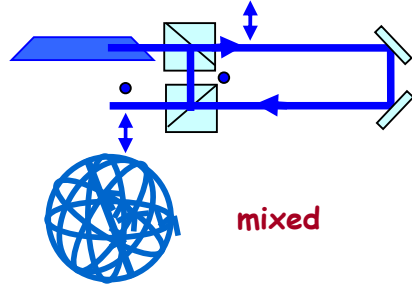

Fig.3

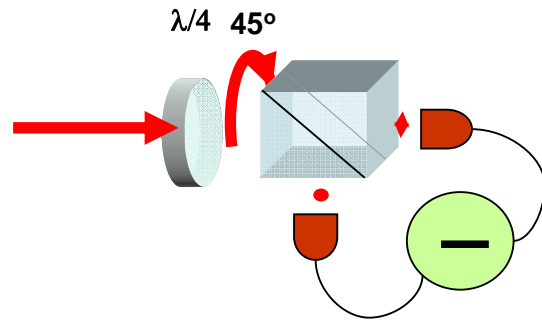

Fig.4

This is done with a quarter-wave plate in front of the polarization prism (we will discuss further in this lecture how different plates transform the polarization).

3. Stokes operators and arbitrarily polarized single-photon states

Stokes operators. In quantum optics, instead of the Stokes parameters we introduce the Stokes operators by changing intensities to photon-number operators:

$$\hat{S}_0 \equiv \hat{N}_H + \hat{N}_V, \quad \hat{S}_1 \equiv \hat{N}_H - \hat{N}_V, \\ \hat{S}_2 \equiv \hat{N}_D - \hat{N}_A = a_H^\dagger a_V + a_V^\dagger a_H, \quad \hat{S}_3 \equiv \hat{N}_L - \hat{N}_R = (a_H^\dagger a_V - a_V^\dagger a_H) / i,$$

where $\hat{N}_H \equiv a_H^\dagger a_H$ and so on. Note that the choice of the mode (H,V,D,A,L,R) is arbitrary; they are all equivalent but orthogonal pairwise. What does orthogonality of two polarization modes mean?

- (1) There is no interference between fields in these modes;
- (2) Fields in these modes are statistically independent;
- (3) (Quantum) The corresponding photon creation and annihilation operators commute: $[a_H^\dagger, a_V] = [a_L^\dagger, a_R] = \dots = 0$, the corresponding observables can be measured simultaneously and so on.

The term ‘Stokes parameters’ will further refer to the *mean values* of the Stokes operators.

Commutation and uncertainty relations. One can see that the Stokes operators $\hat{S}_1, \hat{S}_2, \hat{S}_3$ do not commute while \hat{S}_0 commutes with all of them:

$$[\hat{S}_1, \hat{S}_2] = [a_H^\dagger a_H - a_V^\dagger a_V, a_H^\dagger a_V + a_V^\dagger a_H] = [a_H^\dagger a_H, a_H^\dagger a_V] + [a_H^\dagger a_H, a_V^\dagger a_H] - [a_V^\dagger a_V, a_H^\dagger a_V] - [a_V^\dagger a_V, a_V^\dagger a_H] = a_H^\dagger [a_H, a_H^\dagger] a_V + a_V^\dagger [a_H^\dagger, a_H] a_H - a_H^\dagger [a_V^\dagger, a_V] a_V - a_V^\dagger [a_V, a_V^\dagger] a_H = a_H^\dagger a_V - a_V^\dagger a_H + a_H^\dagger a_V - a_V^\dagger a_H = 2i\hat{S}_3; \\ [\hat{S}_0, \hat{S}_2] = [a_H^\dagger a_H + a_V^\dagger a_V, a_H^\dagger a_V + a_V^\dagger a_H] = [a_H^\dagger a_H, a_H^\dagger a_V] + [a_H^\dagger a_H, a_V^\dagger a_H] + [a_V^\dagger a_V, a_H^\dagger a_V] + [a_V^\dagger a_V, a_V^\dagger a_H] = a_H^\dagger [a_H, a_H^\dagger] a_V + a_V^\dagger [a_H^\dagger, a_H] a_H + a_H^\dagger [a_V^\dagger, a_V] a_V + a_V^\dagger [a_V, a_V^\dagger] a_H = a_H^\dagger a_V - a_V^\dagger a_H - a_H^\dagger a_V + a_V^\dagger a_H = 0$$

Similarly, one can prove all commutation relations:

$$[\hat{S}_1, \hat{S}_2] = 2i\hat{S}_3; \\ [\hat{S}_2, \hat{S}_3] = 2i\hat{S}_1; \\ [\hat{S}_3, \hat{S}_1] = 2i\hat{S}_2; \\ [\hat{S}_0, \hat{S}_1] = [\hat{S}_0, \hat{S}_2] = [\hat{S}_0, \hat{S}_3] = 0.$$

From these, the uncertainty relations follow:

$$\Delta S_i \Delta S_j \geq \left| \langle S_k \rangle \right|, \quad k \neq i \neq j.$$

Physically, it means that different Stokes observables cannot be measured simultaneously unless one of the three is zero. This uncertainty relation is different from the one for the quadratures where there is a constant in the right-hand part.

Single-photon wavepacket. This is the main state considered in quantum polarization optics. At Lecture 7, we discussed a single-photon Fock state $|1\rangle$ in a single mode.

But in polarization optics, we still assume that it is a superposition of single photons in two polarization modes, the qubit:

$$|\Psi\rangle = \alpha|H\rangle + \beta|V\rangle = (\alpha a_H^\dagger + \beta a_V^\dagger)|0\rangle, \quad |\alpha|^2 + |\beta|^2 = 1.$$

A photon polarized horizontally is then given by $\alpha = 1, \beta = 0$.

Home task 1:

Write the state of a photon polarized (1) diagonally (D); right-circularly (R). Hint: in a circularly polarized wave the V component overtakes the H one by a certain phase.

A weak coherent state. Because it is very difficult to obtain a single-photon state, applications (like quantum key distribution) use a weak coherent state instead of a single-photon Fock state. This is possible because, as we know from Lecture 6, a coherent state can be written as a superposition over Fock states,

$$|z\rangle = \sum_{N=0}^{\infty} \frac{1}{\sqrt{N!}} e^{-|z|^2/2} z^N |N\rangle.$$

Therefore, if $|z| \ll 1$, one can write

$$|z\rangle \approx e^{-|z|^2/2} |0\rangle + ze^{-|z|^2/2} |1\rangle,$$

and if the vacuum part of the state does not matter (it often happens), then the state is similar to a single-photon Fock one.

Eigenvalues and eigenstates. Let us find single-photon eigenstates for the Stokes operators and the corresponding eigenvalues. We will solve equations like

$$\hat{S}_k |\Psi\rangle = s_k |\Psi\rangle$$

for $|\Psi\rangle = \alpha|H\rangle + \beta|V\rangle$.

1) The first Stokes operator:

$$\hat{S}_1(\alpha|H\rangle + \beta|V\rangle) = s_1(\alpha|H\rangle + \beta|V\rangle)$$

$$(a_H^\dagger a_H - a_V^\dagger a_V)(\alpha|H\rangle + \beta|V\rangle) = s_1(\alpha|H\rangle + \beta|V\rangle)$$

$$\alpha|H\rangle - \beta|V\rangle = s_1(\alpha|H\rangle + \beta|V\rangle)$$

Leaving in the left-hand part the state vector $\sim |H\rangle$ and in the right-hand part, the state vector $\sim |V\rangle$, we have to assume that the factors standing by them are zero:

$$\alpha(1 - s_1)|H\rangle = (1 + s_1)\beta|V\rangle.$$

So either $s_1 = 1$, $\beta = 0$, and $|\Psi\rangle = |H\rangle$, or $s_1 = -1$, $\alpha = 0$, and $|\Psi\rangle = |V\rangle$

So we got two eigenstates (single photon polarized vertically and horizontally) and two eigenvalues (1 and -1).

2) The second Stokes operator:

$$\hat{S}_2(\alpha|H\rangle + \beta|V\rangle) = s_2(\alpha|H\rangle + \beta|V\rangle)$$

$$(a_H^\dagger a_V + a_V^\dagger a_H)(\alpha|H\rangle + \beta|V\rangle) = s_2(\alpha|H\rangle + \beta|V\rangle)$$

$$\alpha|V\rangle + \beta|H\rangle = s_2(\alpha|H\rangle + \beta|V\rangle)$$

Similarly to the previous case,

$$(\beta - s_2\alpha)|H\rangle = (\beta s_2 - \alpha)|V\rangle.$$

So $\beta = s_2\alpha$ and $\alpha = \beta s_2$. By multiplying these equations, we get $s_2^2 = 1$, and

either $s_2 = 1$, $\beta = \alpha$, and $|\Psi\rangle = \frac{1}{\sqrt{2}}(|H\rangle + |V\rangle) \equiv |D\rangle$, or $s_2 = -1$, $\beta = -\alpha$,

and $|\Psi\rangle = \frac{1}{\sqrt{2}}(|H\rangle - |V\rangle) \equiv |A\rangle$.

Again, we got two eigenstates (single photon polarized diagonally and anti-diagonally) and the same two eigenvalues.

- 3) The case of the third Stokes operator is similar. The eigenstates will be single photons polarized left- and right-circularly, and the eigenvalues will be again 1 and -1.
- 4) The case of the zeroth Stokes operator is degenerate. It will have all single-photon states as eigenstates, and the eigenvalues will be all 1.

Measurement from the viewpoint of quantum optics. For measuring a certain Stokes observable, one should perform the projection on the corresponding eigenstate. This is done with the setup shown in Fig.4; for instance, for S_1 measurement there should be just the polarizing prism and two ‘click’ detectors. If the upper detector clicks, we say that the photon is horizontally polarized, and write down the result $S_1 = 1$ (Fig.5). Then the mean value (the first Stokes parameter) is calculated by averaging the

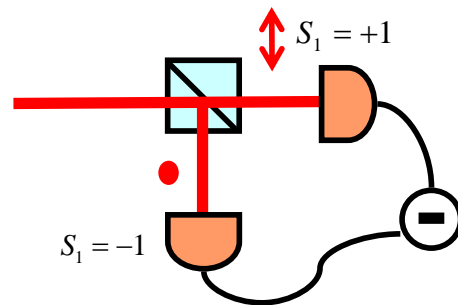

Fig.5

results of all tries: $\langle S_1 \rangle = \frac{1}{n} \sum_{i=1}^n S_{1i}$. The same

way the variance can be calculated.

Measurement of the other Stokes parameters will be similar (a waveplate and rotation should be added to the polarization prism).

Note that if the photon is polarized other than horizontally or vertically (for instance, it is in the state $|D\rangle$), it will be reflected or transmitted with some probability (50% if the state is $|D\rangle$), and its detection does not tell us much. The fact that the photon was detected, say, in the ‘transmitted path’ tells us only that it was not polarized vertically.

This clearly demonstrates the impossibility to measure simultaneously non-commuting Stokes observables. In classical optics, a beam can be split in 3 and in each one, a different Stokes parameter can be measured. But for a single-photon quantum state, this is principally impossible as the photon will be absorbed in just one setup.

Poincare-sphere representation. The normalized Stokes vector is given by two real values and can therefore be depicted by a point on a sphere (Fig.6). Similarly, a single-photon state can be shown on the sphere as a point. This is the Poincare sphere, similar to the Bloch sphere as the description of a single polarized photon is similar to the description of a two-level system. It is important that both the state and the operator can be shown on this sphere.

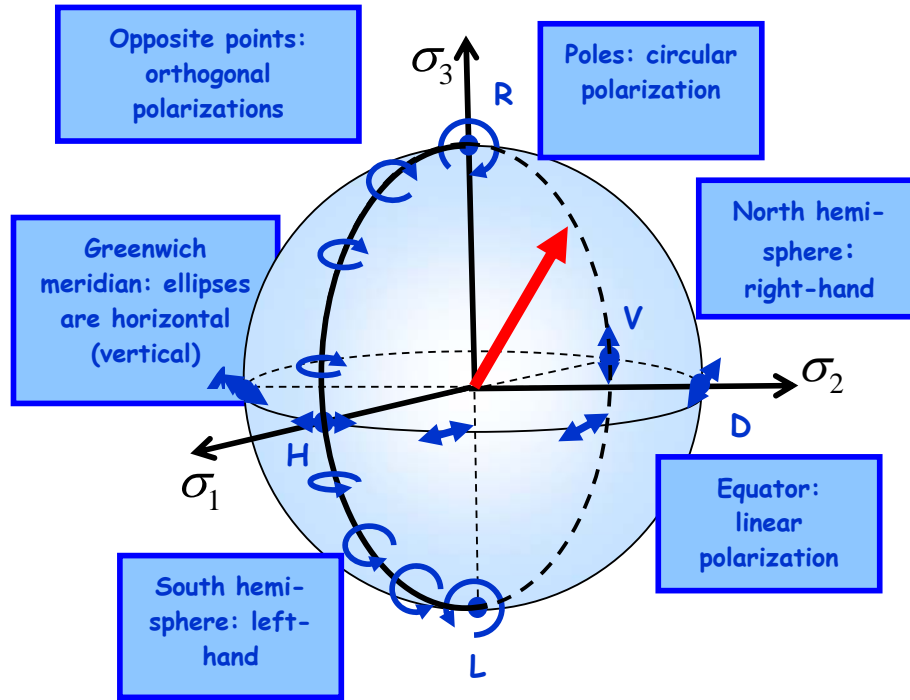

Fig.6

4. Polarization transformations.

Schrödinger and Heisenberg approaches in polarization optics. In polarization optics, the evolution of the state and operators is mostly not in time, but due to polarization transformations. There are elements that change the polarization of light: phase plates (half-wave and quarter-wave), polarizers, polarization-active media (sugar solution, a Faraday cell, or a quartz crystal, for instance), and others. There are two ways to describe this evolution, as always:

- (1) Schrödinger's picture: the operators are the same, a_H^+, a_H, a_V^+, a_V , but the state changes: $|\Psi\rangle \equiv \alpha|H\rangle + \beta|V\rangle \rightarrow |\Psi'\rangle \equiv \alpha'|H\rangle + \beta'|V\rangle$.
- (2) Heisenberg's picture: the state is the same, $|\Psi\rangle \equiv \alpha|H\rangle + \beta|V\rangle$, but the operators change: $a_H^+, a_H, a_V^+, a_V \rightarrow a_H'^+, a_H', a_V'^+, a_V'$.

Jones matrices. In both cases, one can introduce the quantum Jones vector $\vec{e} \equiv \{a_H, a_V\}$, which is absolutely similar to the classical one in the Heisenberg picture. In the Schrödinger picture, the vector is $\vec{e} \equiv \{\alpha, \beta\}$; here it describes the state and not the operator.

Transformations from one Jones vector to another are in both cases given by the Jones matrices: $\vec{e} \rightarrow \vec{e}' = D\vec{e}$. These matrices are complex, in the general case, and 2x2; they should be unitary (energy conservation) and their trace can be chosen to be zero because the Jones vector is phase-irrelevant. Such a matrix is called an SU(2) matrix (it represents the SU(2) group) and is similar to the matrix describing a beamsplitter. Its general form is given by

$$D = \begin{pmatrix} t & r \\ -r^* & t^* \end{pmatrix}, \quad |t|^2 + |r|^2 = 1.$$

Jones matrices of phase plates. A phase plate is just a piece of birefringent material (usually, quartz) cut in such a way that the optic axis is in the plane. Its parameters are the phase

$\delta = \frac{\pi \Delta n d}{\lambda}$ and the orientation χ (the angle between its optic axis and the horizontal direction). Here, Δn is the birefringence, d is the thickness, λ the wavelength. For a half-wave plate (HWP) $\delta = \frac{\pi}{2}$, for a quarter-wave plate (QWP) $\delta = \frac{\pi}{4}$.

Then, the Jones matrix of a phase plate has the following parameters:

$$t = \cos \delta + i \sin \delta \cos 2\chi; \quad r = i \sin \delta \sin 2\chi.$$

Home task 2:

Calculate the Jones matrix for a quarter and half wave plate and check how they act on a horizontally polarized single photon.

Mueller matrices describe the transformation of the Stokes vector provided that the Jones vector is transformed by the Jones matrices: $\vec{\sigma} \rightarrow \vec{\sigma}' = M \vec{\sigma}$. From symmetry considerations, one can show that these real-valued matrices correspond to rotations (they represent the $SO(3)$ group). Therefore, it is convenient to show them on the Poincare sphere (Fig.8). The rule is as follows (we have to omit the proof): for a plate with the parameters δ, χ the rotation is around an axis oriented at 2χ to σ_1 and by an angle 2δ . Hence, a HWP rotates a point by π around various axes, depending on its orientation. For instance, a right circular polarization it always transforms into left circular and vice versa. And a linear polarization is transformed into linear. A QWP rotates the state by $\pi/2$, hence, if oriented at $\pi/4$, it transforms a circular polarization into linear and vice versa.

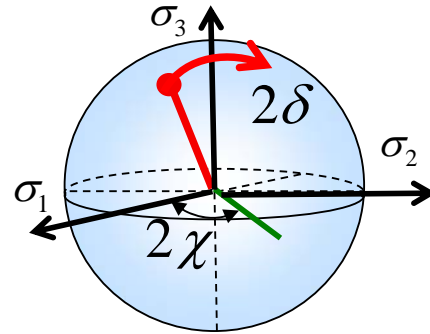

Fig.8